

# TRIODE ELECTRONICS 5F1 TWEED CHAMP LAYOUT

120V Operation w/ 40-18027 Power Transformer

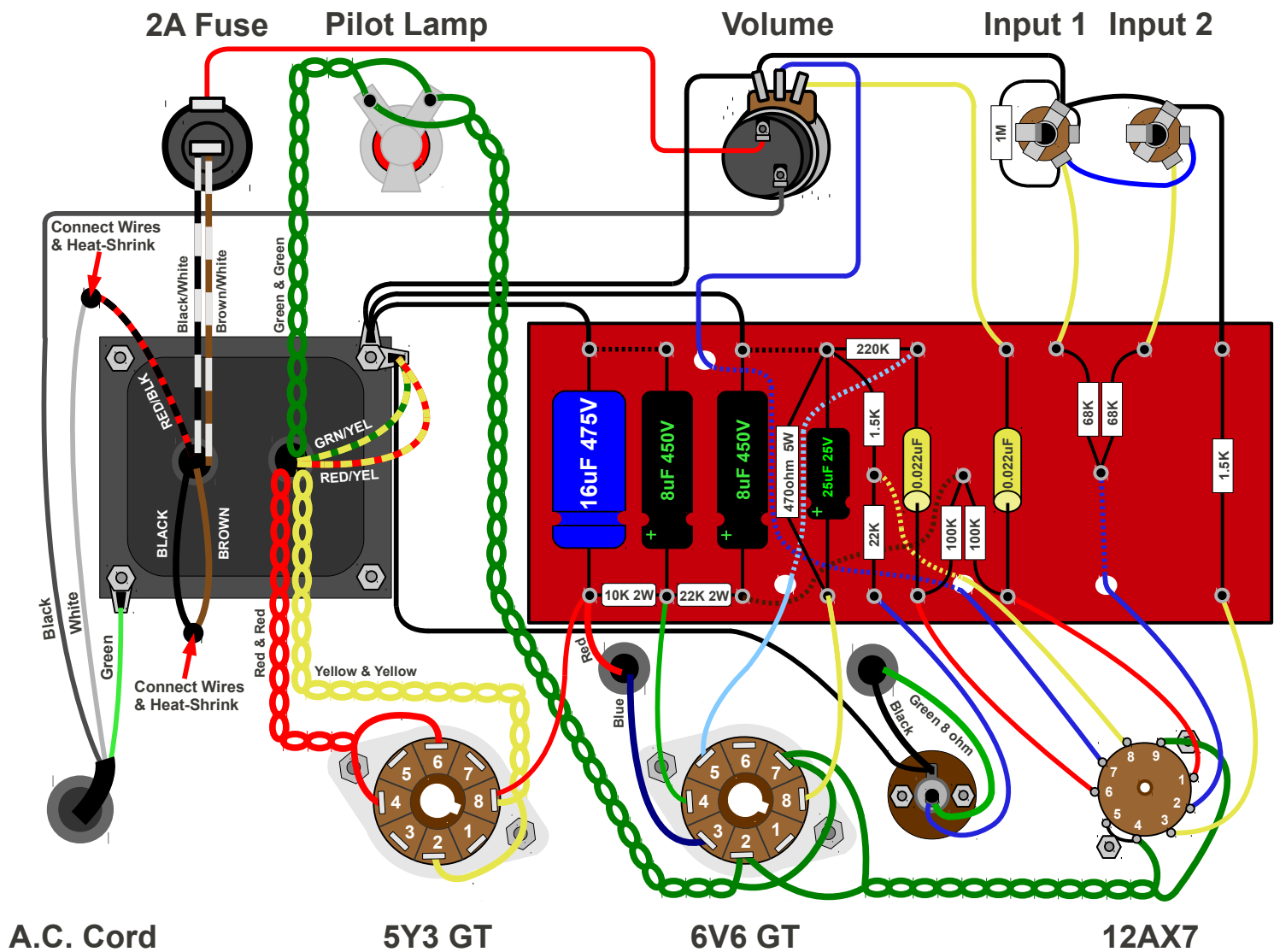

## Notes:

- \*Twist filament wires together tightly.
- \*Check Polarity (+ & -) of all Electrolytic Capacitors.
- \*Brown Wire from Output Transformer & Both Red/White Wires from the Power Transformer are Not Used. These should be tied off and insulated. **(Do Not Connect Together!)**
- \*Yellow Wire from Output Transformer is a 4 ohm tap, if you don't wish to use, tie off and insulate.
- \*All Resistors are 1/2W Unless Noted Otherwise.
- \*Power Transformer: 40-18027
- \*Output Transformer: 40-18030

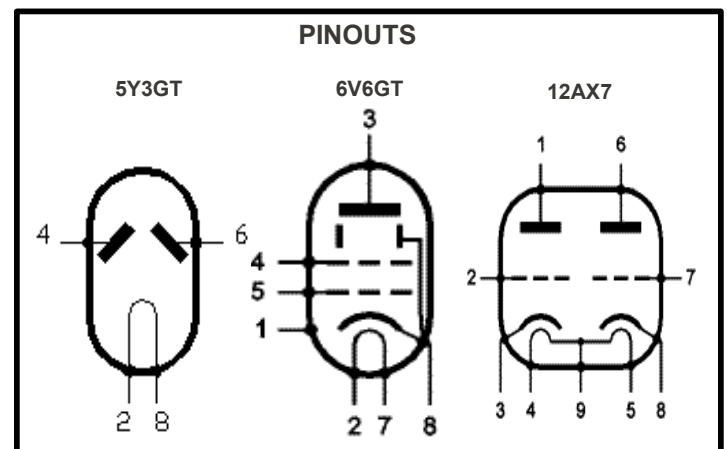

For Technical Questions or Comments, Email us at: [questions@triodestore.com](mailto:questions@triodestore.com)